

C800S Power Package

Low-pressure Natural Gas, ICHP

The Signature Series Microturbine provides ultra-low emissions and reliable electrical/thermal generation from natural gas.



C800S ICHP Power Package

Electrical Performance⁽¹⁾

Electrical Power Output	760kW
Voltage	400/480 VAC
Electrical Service	3-Phase, 4 Wire Wye
Frequency	50/60 Hz
Electrical Efficiency LHV	31%

Fuel/Engine Characteristics⁽¹⁾

Natural Gas HHV	35.4–42.8 MJ/m ³ (950–1,150 BTU/scf)
Inlet Pressure ⁽²⁾	1.7–34.5 kPa gauge (0.25–5.0 psig)
Fuel Flow HHV	9,720 MJ/hr (9,200,000 BTU/hr)
Net Heat Rate LHV	11.6 MJ/kWh (11,000 BTU/kWh)

Exhaust Characteristics⁽¹⁾

NOx Emissions @ 15% O ₂	< 9 ppmvd (18 mg/m ³)
Exhaust Mass Flow	5.3 kg/s (11.7 lbm/s)
Exhaust Gas Temperature	280°C (535°F) (Heat Recovery Bypassed)

Benefits

- Ultra-low emissions
- One moving part – minimal maintenance and downtime
- Patented air bearings – no lubricating oil or coolant
- Integrated utility synchronization – no external switchgear
- Internal fuel gas compressor housed within enclosure
- Compact modular design allows for easy, low-cost installation
- High electrical efficiency over a very wide operating range
- High availability – part load redundancy
- Remote monitoring and diagnostic capabilities
- Proven technology with tens of millions of operating hours
- Various Factory Protection Plans available

**Smarter Energy
for a Cleaner Future**

Dimensions & Weight⁽³⁾

Width x Depth x Height	3.0 x 7.5 x 4.0 m (117 x 295 x 157 in)
Weight - Grid Connect Model, dry	18,500 kg (40,800 lbs)
Weight - Dual Mode Model, dry	21,300 kg (47,000 lbs)

Minimum Clearance Requirements⁽⁴⁾

Horizontal Clearance	
Left	1.5 m (60 in)
Right	0.0 m (0 in)
Front	1.7 m (65 in)
Rear	2.2 m (85 in)

ICHP Heat Recovery⁽⁵⁾

Hot Water Heat Recovery	1.2 MW (4.1 MMBtu/hr)
-------------------------	-----------------------

Certifications

- UL 2200 Listed
- CE Certified
- Certified to the following grid interconnections standards: UL 1741-SA, VDE, BDEW, CEI 0-16, AS4777
- Compliant to California Rule 21

C200 Engine Components

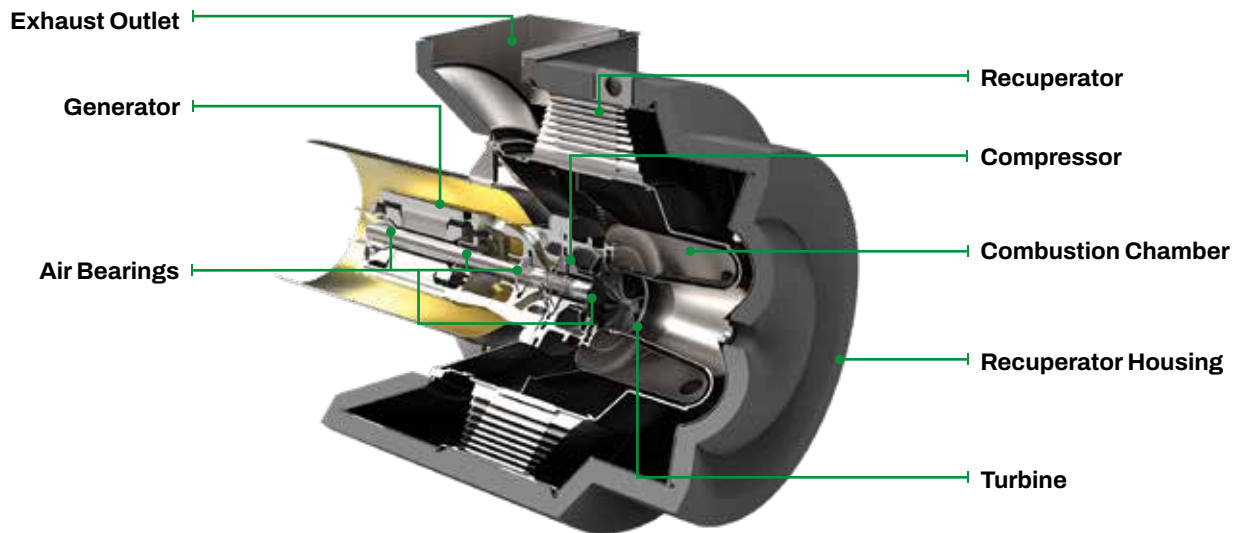

(1) Nominal full power performance at ISO conditions: 15°C (59°F), 14.696 psia, 60% RH
 (2) For critical cyclic (on/off) applications, a gas inlet pressure of 5 psig may be a requirement. Consult with Capstone's Application Engineering team
 (3) Approximate dimensions and weights
 (4) Clearance requirements may increase due to local code considerations
 (5) Nominal heat recovery using 4 Heat Recovery Modules (HRM). Inlet water temperature of 38°C (100°F) and flow rate of 6.3 l/s (100 gpm) per HRM
Specifications are not warranted and are subject to change without notice.