

C600S Megawatt Power Package

Liquid Fuels



The Signature Series Microturbine provides 600kW of reliable electrical power in one small, ultra-low emission, and highly efficient package.

- + Ultra-low emissions
- + One moving part – minimal maintenance and downtime
- + Patented air bearings – no lubricating oil or coolant
- + Integrated utility synchronization – no external switchgear
- + Compact modular design allows for easy, low-cost installation
- + High electrical efficiency over a very wide operating range
- + High availability – part load redundancy
- + Remote monitoring and diagnostic capabilities
- + Proven technology with tens of millions of operating hours
- + Various Factory Protection Plans available



C600S Power Package

Electrical Performance⁽¹⁾

Electrical Power Output	570kW
Voltage	400/480 VAC
Electrical Service	3-Phase, 4 Wire Wye
Frequency	50/60 Hz
Electrical Efficiency LHV	31%

Fuel/Engine Characteristics⁽¹⁾

Liquid Fuels	Diesel (ASTM D975-10, No. 2-D, S15)
Inlet Pressure	3.4–35.4 kPa gauge (0.5–5.0 psig)
Fuel Flow HHV	7,200 MJ/hr (6,840,000 BTU/hr)
Net Heat Rate LHV	36 MJ/kWh (34,110 BTU/kWh)

Exhaust Characteristics⁽¹⁾

Exhaust Mass Flow	4.0 kg/s (8.8 lbm/s)
Exhaust Gas Temperature	280°C (535°F)

Dimensions & Weight⁽²⁾

Width x Depth x Height ⁽³⁾	3.1 x 9.1 x 2.9 m (121 x 360 x 114 in)
Weight - Grid Connect Model	15,000 kg (33,100 lbs)
Weight - Dual Mode Model	17,200 kg (37,800 lbs)

Minimum Clearance Requirements⁽⁴⁾

Horizontal Clearance	
Left	1.5 m (60 in)
Right	0.0 m (0 in)
Front	1.7 m (65 in)
Rear	2.0 m (80 in)

Certifications

- Certified to the following grid interconnection standards: UL 1741, VDE, BDEW and CEI

C200 Engine Components

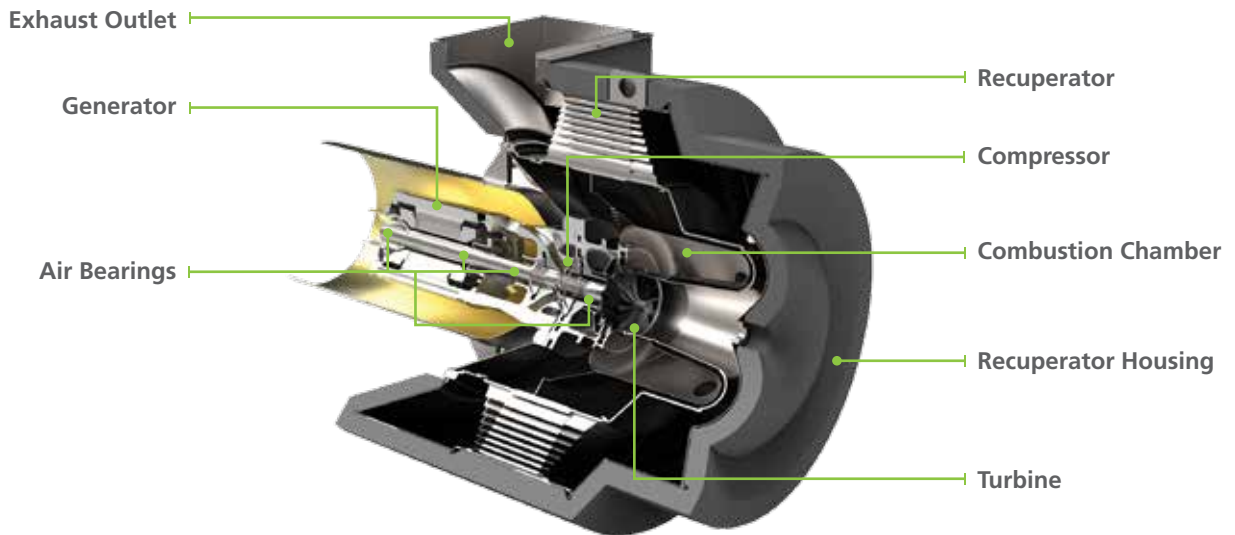

(1) Nominal full power performance at ISO conditions: 15°C (59°F), 14.696 psia, 60% RH
 (2) Approximate dimensions and weights
 (3) Height dimensions are to the roof line. Exhaust outlet extends at least 152 mm (6 in) above the roofline
 (4) Clearance requirements may increase due to local code considerations
 Specifications are not warranted and are subject to change without notice.

