

C600S Megawatt Power Package

High-pressure Natural Gas



The Signature Series Microturbine provides 600kW of reliable electrical power in one small, ultra-low emission, and highly efficient package.

- + Ultra-low emissions
- + One moving part – minimal maintenance and downtime
- + Patented air bearings – no lubricating oil or coolant
- + Integrated utility synchronization – no external switchgear
- + Compact modular design allows for easy, low-cost installation
- + High electrical efficiency over a very wide operating range
- + High availability – part load redundancy
- + Remote monitoring and diagnostic capabilities
- + Proven technology with tens of millions of operating hours
- + Various Factory Protection Plans available



C600S Power Package

Electrical Performance⁽¹⁾

Electrical Power Output	600kW
Voltage	400/480 VAC
Electrical Service	3-Phase, 4 Wire Wye
Frequency	50/60 Hz
Electrical Efficiency LHV	33%

Fuel/Engine Characteristics⁽¹⁾

Natural Gas HHV	30.7–47.5 MJ/m ³ (825–1,275 BTU/scf)
Inlet Pressure	517–551 kPa gauge (75–80 psig)
Fuel Flow HHV	7,200 MJ/hr (6,840,000 BTU/hr)
Net Heat Rate LHV	32.7 MJ/kWh (30,900 BTU/kWh)

Exhaust Characteristics⁽¹⁾

NO _x Emissions @ 15% O ₂	< 9 ppmvd (18 mg/m ³)
Exhaust Mass Flow	4.0 kg/s (8.8 lbm/s)
Exhaust Gas Temperature	280°C (535°F)

Dimensions & Weight⁽²⁾

Width x Depth x Height ⁽³⁾	3.0 x 9.1 x 2.9 m (117 x 360 x 114 in)
Weight - Grid Connect Model	14,200 kg (31,300 lbs)
Weight - Dual Mode Model	16,300 kg (35,900 lbs)

Reliable power when and where you need it. Clean and simple.

Minimum Clearance Requirements⁽⁴⁾

Horizontal Clearance	
Left	1.5 m (60 in)
Right	0.0 m (0 in)
Front	1.7 m (65 in)
Rear	2.0 m (80 in)

Certifications

- UL 2200 Listed
- CE Certified
- Certified to the following grid interconnection standards: UL 1741, VDE, BDEW and CEI
- Compliant to California Rule 21 and New York State Public Service Commission

C200 Engine Components

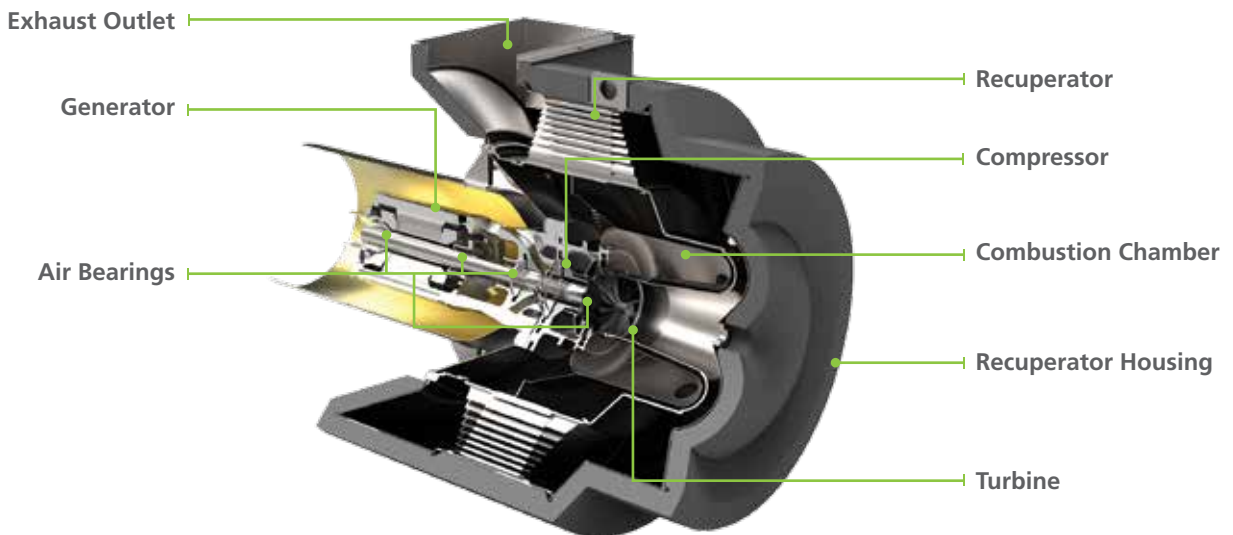

(1) Nominal full power performance at ISO conditions: 15°C (59°F), 14.696 psia, 60% RH
 (2) Approximate dimensions and weights
 (3) Height dimensions are to the roof line. Exhaust outlet extends at least 152 mm (6 in) above the roofline
 (4) Clearance requirements may increase due to local code considerations
 Specifications are not warranted and are subject to change without notice.

